

**GENERAL**

Coiltronics 1210 Series Chip Inductors are ideally suited for signal and moderate power circuit SMT applications. Both the CTX32 and CTX32C Product Families are designed to provide superior reliability due to their rugged ceramic case construction. Precise manufacturing processes provide mechanically sound devices which maintain tolerance specifications. The devices are supplied in 8 mm tape and reel packaging which facilitates automatic assembly insertion.



Coiltronics designs and manufactures many standard and custom electro-magnetic components. Contact the factory or your nearest Coiltronics representative or distributor with your transformer and inductor requirements.

- Operating Temperature Range: -25°C to +85°C
- Storage Temperature Range: -40°C to +125°C
- Resistance to Soldering: Can withstand +260°C for up to 10 seconds
- Resistance to Solvents: Conforms to MIL-STD-202E
- Coefficient of Expansion:  $6.7 \times 10^{-6}$ ppm/°C (typical)
- Insulation Resistance: 1000 Mohms minimum
- Flammability: Conforms to IEC 695-2-2

**FEATURE - BENEFITS**

- 1210 Series form factor means small footprint and low profile for high density applications
- High Q Rating assures performance reliability
- Tape and Reel Packaging for automatic assembly insertion
- Precision ceramic casing allows high temperature surface mounting and excellent thermal conduction
- Triple-plated terminals enhance reliable solderability
- Available in inductance ranges from 0.1 to 470  $\mu$ H
- Low cost with high performance

**ORDERING INFORMATION**

CTX32 and CTX32X Product Families are supplied in 8mm tape and reel packaging. Each reel contains 2000 inductors.

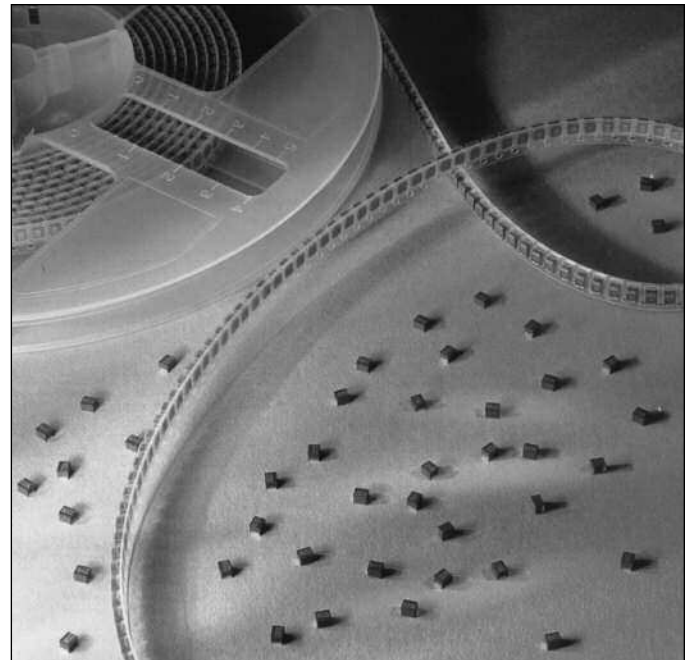

**CONSTRUCTION DIMENSIONS**

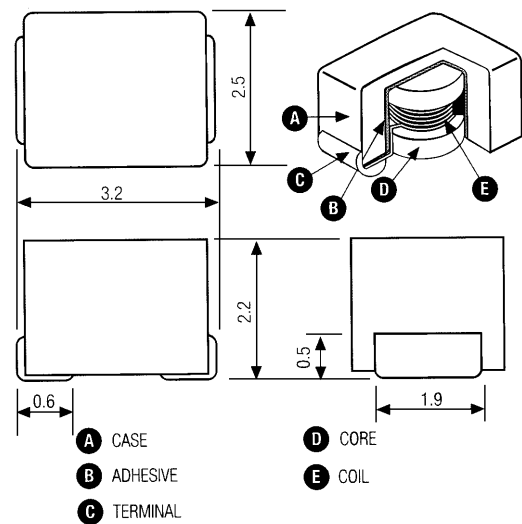

**RECOMMENDED PAD LAYOUT PATTERN**

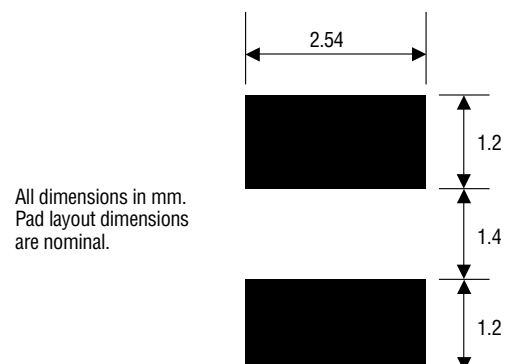

**CTX32 Product Family**

CTX32 Product Family Chip Inductors are ideally suited for low level signal circuit applications.

Coiltronics Part Number	Inductance $\mu\text{H}/\text{TOL}$	Q Min	Test MHz	SRF Min. MHz	$R_{DC}$ Max. Ohms	$I_{DC}$ Rated mA
CTX32T-R12-R	0.12+/-20%	30	25.2	500	.22	450
CTX32T-R15-R	0.15			450	.25	450
CTX32T-R18-R	0.18			400	.28	450
CTX32T-R22-R	0.22			350	.32	450
CTX32T-R27-R	0.27			320	.36	450
CTX32T-R33-R	0.33			300	.40	450
CTX32T-R39-R	0.39			250	.45	450
CTX32T-R47-R	0.47			220	.50	450
CTX32T-R56-R	0.56			180	.55	450
CTX32T-R68-R	0.68			160	.60	450
CTX32T-R82-R	0.82			140	.65	450
CTX32T-1R0-R	1.0		7.96	120	.70	400
CTX32T-1R2-R	1.2			100	.75	390
CTX32T-1R5-R	1.5			85	.85	370
CTX32T-1R8-R	1.8			80	.90	350
CTX32T-2R2-R	2.2			75	1.00	320
CTX32T-2R7-R	2.7			70	1.10	290
CTX32T-3R3-R	3.3			60	1.20	260
CTX32T-3R9-R	3.9			55	1.30	250
CTX32T-4R7-R	4.7			50	1.50	220
CTX32T-5R6-R	5.6			47	1.60	200
CTX32T-6R8-R	6.8			43	1.80	180
CTX32T-8R2-R	8.2			40	2.00	170
CTX32T-100-R	10.0+/-10%		2.52	36	2.10	150
CTX32T-120-R	12.0			33	2.50	140
CTX32T-150-R	15.0			30	2.80	130
CTX32T-180-R	18.0			27	3.30	120
CTX32T-220-R	22.0			25	3.70	110
CTX32T-270-R	27.0			20	5.00	80
CTX32T-330-R	33.0			17	5.60	70
CTX32T-390-R	39.0			16	6.40	65
CTX32T-470-R	47.0			15	7.00	60
CTX32T-560-R	56.0			13	8.00	55
CTX32T-680-R	68.0			12	9.00	50
CTX32T-820-R	82.0			11	10.00	45
CTX32T-101-R	100.0	20	0.796	10	10.00	40
CTX32T-121-R	120.0			10	11.00	70
CTX32T-151-R	150.0			8	15.00	65
CTX32T-181-R	180.0			7	17.00	60
CTX32T-221-R	220.0			7	21.00	50
CTX32T-271-R	270.0			6	28.00	45
CTX32T-331-R	330.0			5	34.00	40
CTX32T-391-R	390.0			5	42.00	35
CTX32T-471-R	470.0			4	40.00	25

Current ratings are achieved by reducing initial inductance values 10%

**DC BIAS CHARACTERISTICS**

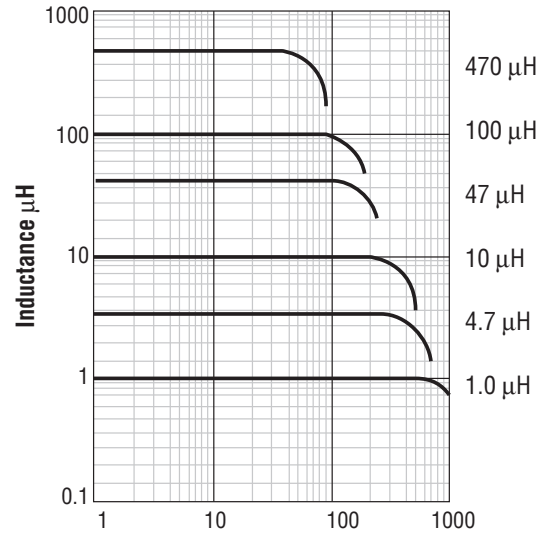

DC Current mA

**INDUCTANCE VS. FREQUENCY**

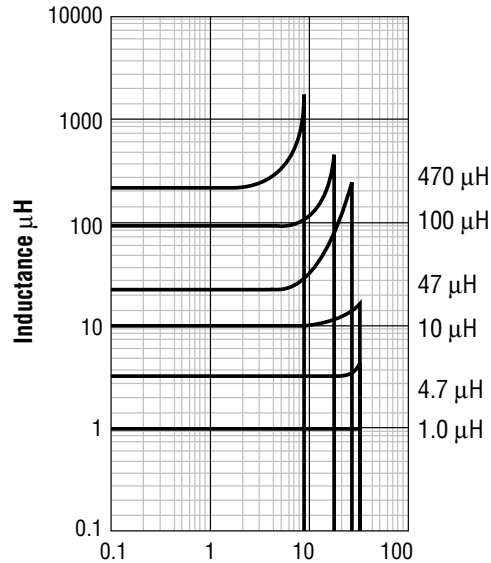

Frequency MHz

**TEMPERATURE CHARACTERISTICS**

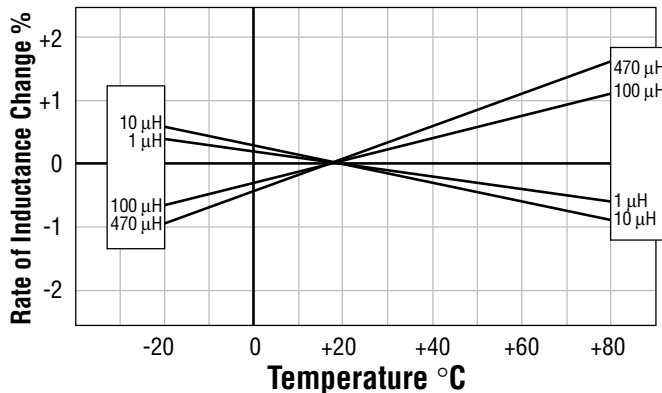

**Q VS. FREQUENCY CHARACTERISTICS**

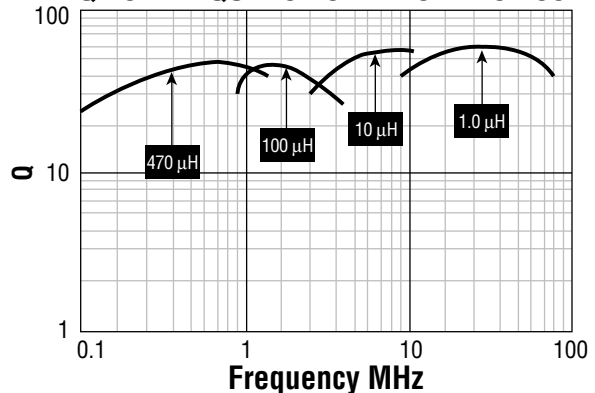

**CTX32C Product Family**

Coiltronics CTX32C Product Family Chip Inductors are ideally suited for moderate power circuit applications. They deliver twice the DC current carrying capability with less than half the DC resistance as the CTX32 Series.

Coiltronics Part Number	Inductance $\mu\text{H}/\text{TOL}$	Q Min	Test MHz	SRF Min.MHz	$R_{DC}$ Max.Ohms	$I_{DC}$ Rated mA
CTX32CT-1R0-R	10.0+/-20%	10	7.96	100	.15	850
CTX32CT-1R5-R	1.5			80	.18	700
CTX32CT-2R2-R	2.2			68	.23	600
CTX32CT-3R3-R	3.3			54	.28	500
CTX32CT-4R7-R	4.7	15		46	.34	430
CTX32CT-6R8-R	6.8			38	.42	360
CTX32CT-100-R	10.0+/-10%		2.52	30	.50	300
CTX32CT-150-R	15.0			26	.74	250
CTX32CT-220-R	22.0			21	1.15	210
CTX32CT-330-R	33.0			17	1.65	170
CTX32CT-470-R	47.0			14	2.25	150
CTX32CT-680-R	68.0			12	3.70	120
CTX32CT-101-R	100.0		0.796	10	5.00	100
CTX32CT-151-R	150.0	20		8	8.00	85
CTX32CT-221-R	220.0			7	11.00	70
CTX32CT-331-R	330.0			6	16.00	60

Current ratings are achieved by reducing initial inductance values 10%

**DC BIAS CHARACTERISTICS**

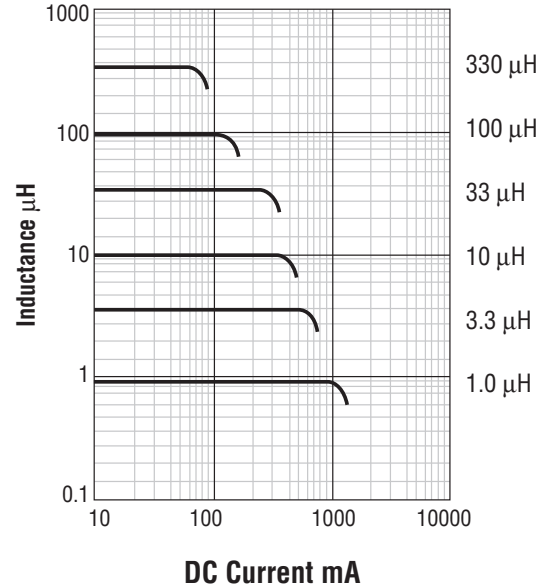

**Q VS. FREQUENCY CHARACTERISTICS**

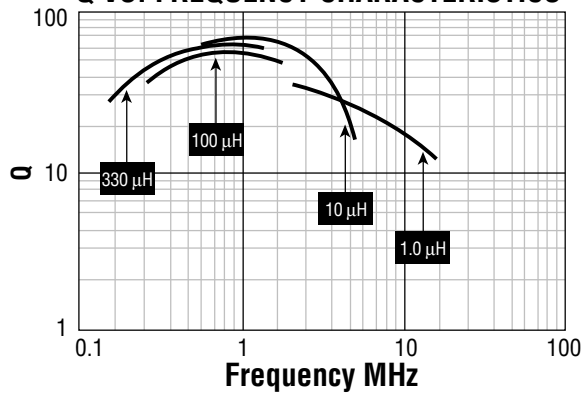

**INDUCTANCE VS. FREQUENCY**

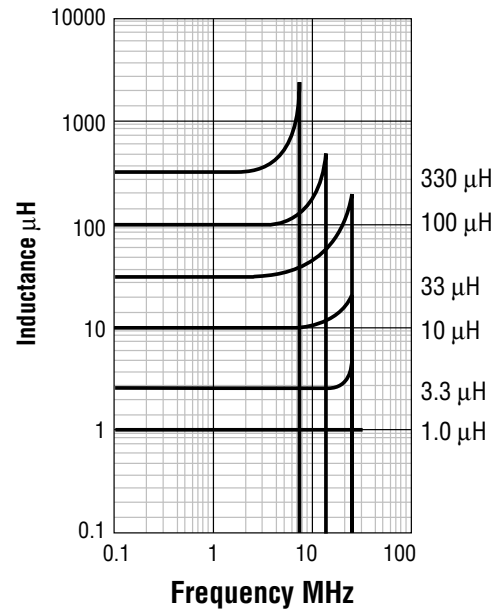

**TEMPERATURE CHARACTERISTICS**

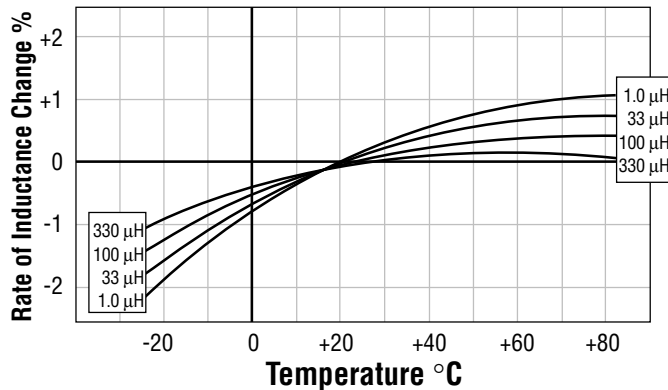

**Visit us on the Web at [www.cooperbussmann.com](http://www.cooperbussmann.com)**

1225 Broken Sound Pkwy. Suite F Boca Raton, FL 33487

Tel: +1-561-998-4100 Toll Free: +1-888-414-2645 Fax: +1-561-241-6640

This bulletin is intended to present product design solutions and technical information that will help the end user with design applications. Cooper Electronic Technologies reserves the right, without notice, to change design or construction of any products and to discontinue or limit distribution of any products. Cooper Electronic Technologies also reserves the right to change or update, without notice, any technical information contained in this bulletin. Once a product has been selected, it should be tested by the user in all possible applications.

Life Support Policy: Cooper Electronic Technologies does not authorize the use of any of its products for use in life support devices or systems without the express written approval of an officer of the Company. Life support systems are devices which support or sustain life, and whose failure to perform, when properly used in accordance with instructions for use provided in the labeling, can be reasonably expected to result in significant injury to the user.